

VANMOOF
ELECTRIFIED S

USER GUIDE / WARRANTY

Your package contains...



CHARGER



**REMOTE
CONTROL**



PEDALS



**ANTI-THEFT
WHEEL NUT TOOL**



ALLEN KEY #4 / #5



WRENCH 15



**ANTI-THEFT
TORX KEY M5 / M6**



DASHBOARD



LOCK / UNLOCK



PARK LOCATION



BIKE SETTINGS

YOUR ELECTRIFIED S IS CRAMMED FULL OF FEATURES. TO MAKE THE MOST OF THEM, DOWNLOAD THE SMARTPHONE APP:

my.vanmoof.com



Components

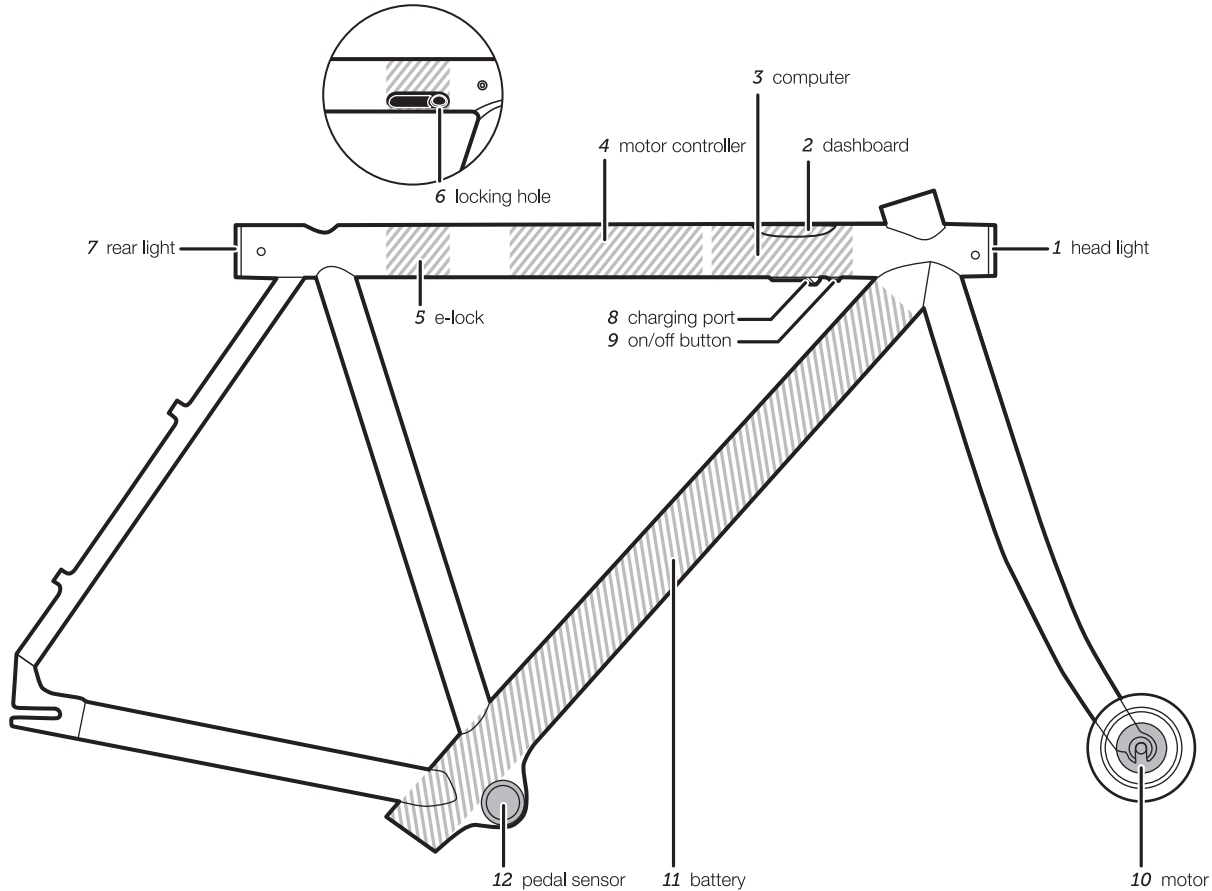

Specs

- Light weight: 18.4 kg including battery
- Anodized aluminum frame
- Automatic 2 speed shifting gears
- Remote locking system
- Top speed of 32 km/h (in USA settings)
- Range: 50km (full power mode) to 120km (economy mode)
- 250 - 350w front-wheel hub motor
- 420wh battery integrated into the frame
- Anti-theft tracking using Bluetooth and GSM technologies
- Compatible app for iOS and Android
- Power-boost button on handlebar

Quick start

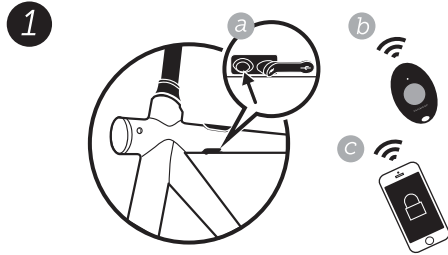
**TURN ON YOUR BIKE**

Either press the button on the underside of the top tube, use the remote control, or switch it on using the smartphone App.

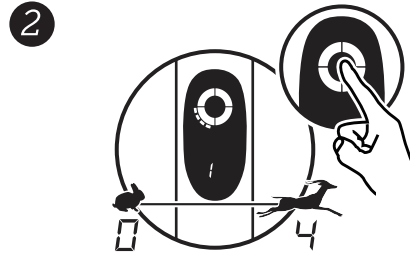
**SET YOUR LEVEL OF POWER ASSIST**

Your bike's power assist goes from 0 (no power) to 4 (full power). You can set it by holding your finger on the control circle at the top of the dashboard. More details on page 13.

5

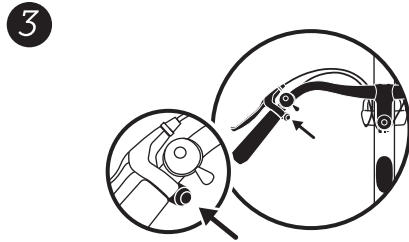
**BOOST BUTTON**

Simply press and hold the boost button while you're pedaling for as long as you need an extra boost. It only works at speeds below 20 km/h (12 mi/h) and is perfect for tackling hills or cross winds.

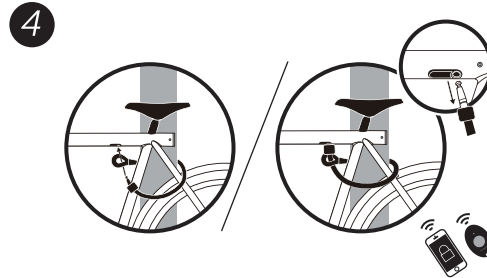
**LOCK & UNLOCK**

To lock, insert the lock pin into the lock pin entrance on the top tube near your seat. To unlock, press the remote control or use the unlock function on the smartphone app. See more on pages 15 and 16.

6

Before you ride

Adjust the saddle

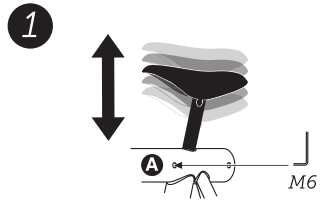

Change the saddle height by inserting the anti-theft torx key M6 into Point A. Maximum saddle height is indicated on the seat post.

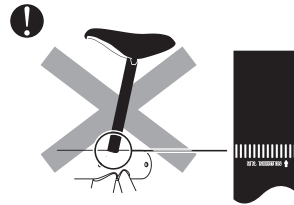

NOTE

Please note the maximum saddle height, indicated on the seat post.

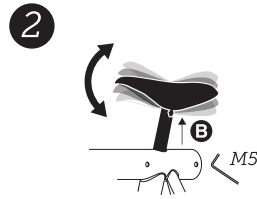

Change the saddle angle by inserting anti-theft torx key M5 into Point B.

Assemble the pedals

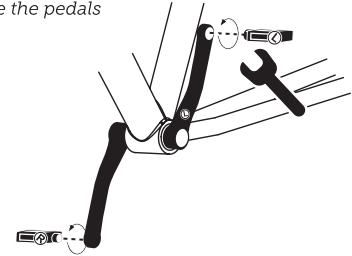

1. Apply grease to the thread.
2. Screw the pedals into the crank using Wrench 15.
3. Tighten the right pedal (we've indicated it with a sticker) using a clockwise motion.
4. Tighten the left pedal using an anticlockwise motion.

7

Adjust the handlebars

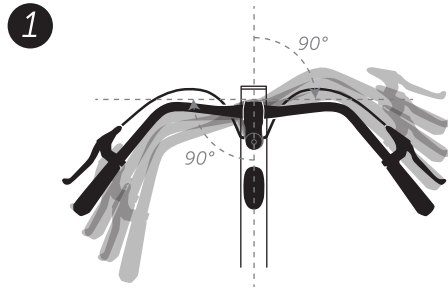

Turn the handlebars to your preferred position.

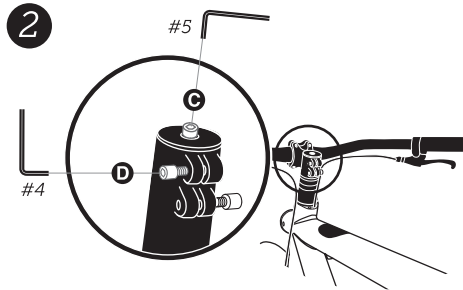

Tighten them by using allen key 5 into Point C, and allen key 4 at Point D.

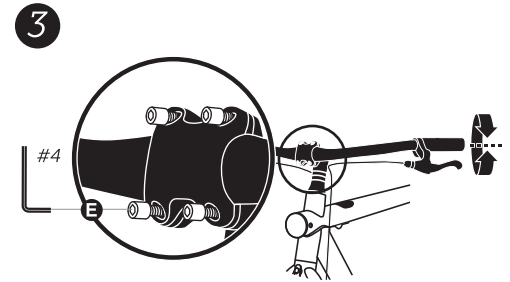

To change the angle of the handlebars, use allen key 4 at Point E.

8

Charging

1

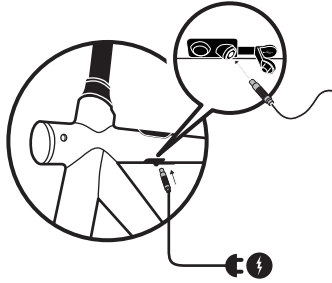

Gently insert the charger in the charging port.

2

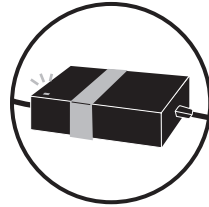

— Green light: fully charged
— Red light: charging

Once it's fully charged the LED on the charger will change from red to green. It should take about 6 hours to fully charge the battery.

3

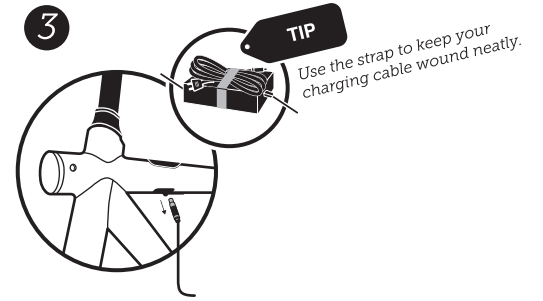

Once the LED has changed to green, disconnect the charger and get back to riding.

9

Charging tips

Follow these simple tips to keep your battery running in perfect condition for longer.

- Only use the official VanMoof battery charger.
- Charge the Electrified S indoors, in a well-ventilated and dry location, as rain and extreme temperature fluctuations can mess with the charging process.
- The bike will charge best at temperatures between 0°C and 50°C.
- Place the charger on a hard surface and make sure it is never covered. Never place it on carpet or textile surfaces.
- Always keep the plug and connector of your charger free of dirt and moisture.
- Do not charge your bike if the charger or plug are damaged. If in doubt, contact us.
- If you're not using your Electrified S for a while, make sure the battery is plugged into the charger, or at least gets a full charge cycle every six months.



Please charge at least every six months.

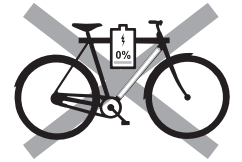

To maintain the battery life, never store the Electrified S longer than one month with a uncharged battery.

10

Dashboard

Elements

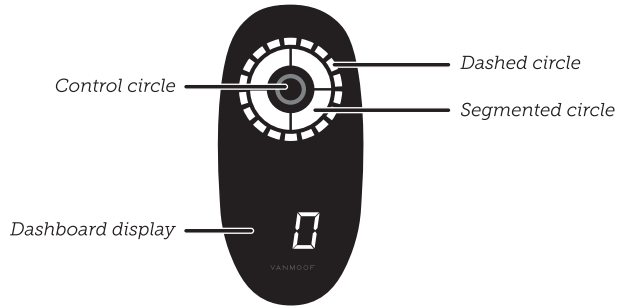

Dashed circle

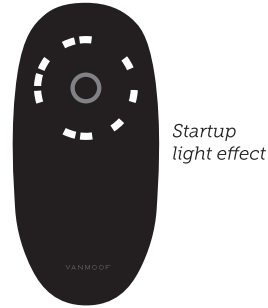

Segmented circle

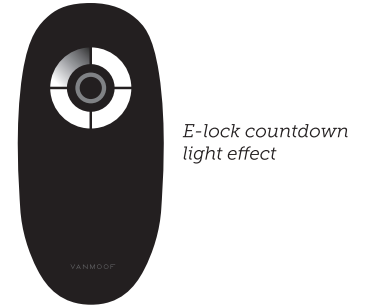

11

Control circle

A



Hold for 2 secs

→ Switch to Power assist mode

See more on page 14

B



Tap once within 10 secs after startup

→ Touch unlock

See more on page 14

12

Dashboard

A Riding mode

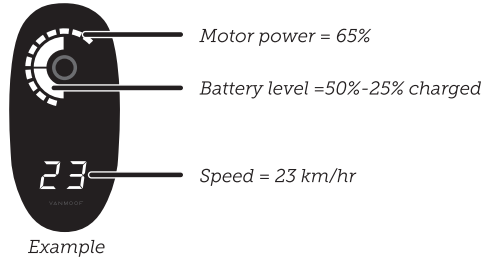

B Battery charge levels

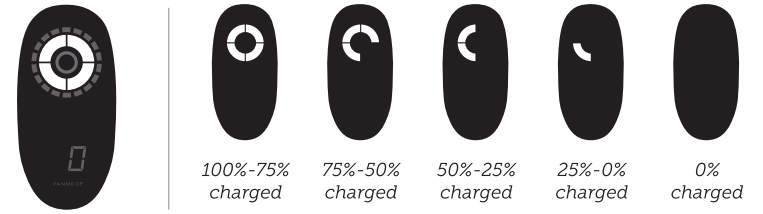

The segmented circle shows the level of battery charge.

13

C Power assist mode

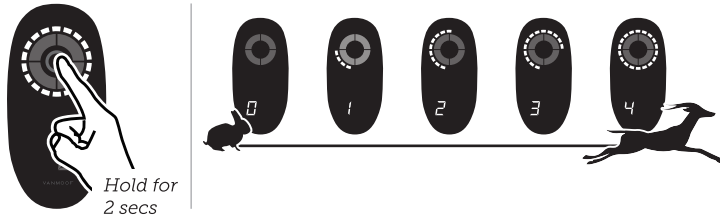

Your bike's power assist goes from 0 (no power) to 4 (full power). You can set it by holding your finger on the control dot at the top the dashboard. Keep holding until the numbers on the dashboard show your desired level of power.

D Touch unlock will be available soon

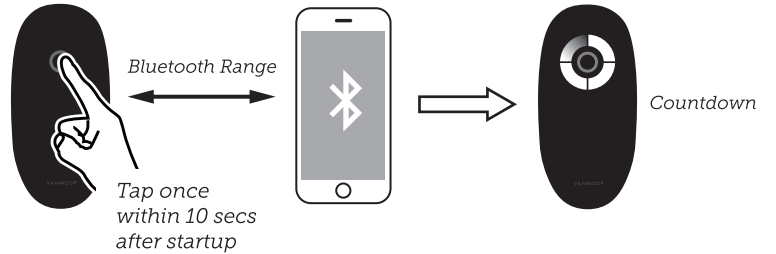

If your VanMoof smartphone app is active and on you, your Electrified S will automatically turn on when you approach it. Simply touch the 'control circle' once within ten seconds to unlock your bike.

14

Locking

A

We highly recommend this way

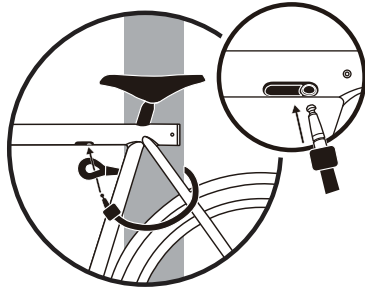

Wrap the locking cable around a fixed object. Pass the locking pin through the loop and insert the locking pin into the locking hole on the underside of the top tube.

15

B

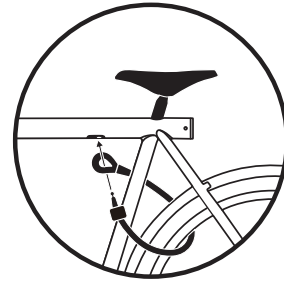

Wrap the locking cable through both the frame and the rear wheel. Pass the locking pin through the loop and insert it into the lock pin entrance on the underside of the top tube.

Unlocking

1

a



b



c

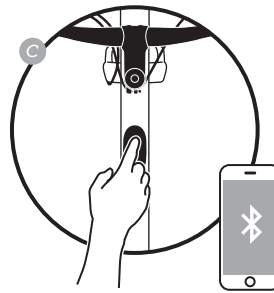

Press the remote control, use the unlock function in the smartphone App, or use the touch unlock function. See more details on page 14.

16

2

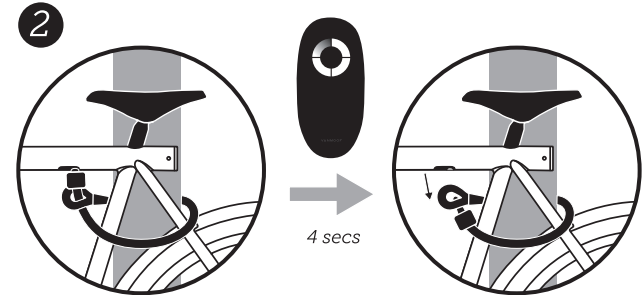

A four-second timer will count down on the dashboard. Within these four seconds simply push the locking pin slightly in, then pull it out.

Love Your Bike

These four simple tips will keep your Electrified S riding happier, for longer.

1



PUMP YOUR TYRES

You'll be 15% more energy-efficient by keeping 3,0 Bar (35 Psi) high pressure in your tyres.

2



LUBRICATE YOUR CHAIN

Apply oil to your chain every two to three months to keep it running sweetly.

3

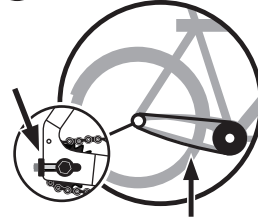

then tighten the bolts again. Our bike doctors are more than happy to help with this one - find out more at vanmoof.com

CHECK YOUR CHAIN

If you press the chain in the middle, it should give way about 1 cm. Any more? Loosen the rear-wheel bolts and move the wheel backwards a little by tightening the chain tensioners with a few thread windings on both sides. Any less? Loosen the rear-wheel bolts and move the wheel forwards a little by releasing the chain tensioners a few thread windings on both sides. Make sure the wheel is properly aligned,

4



CHARGE YOUR BATTERY

Please charge at least every six months.

17

Adding Accessories

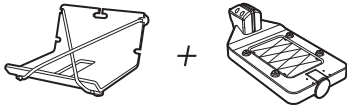

VanMoof BAMBOOMAN CARRIER SET

This sleek wooden carrier is finished with an outer layer of bamboo, and comes with two elastic cords that can be attached to different notches. It's strong enough to carry up to 10kg.



VanMoof WAITRESS CARRIER SET

This carrier is as hard-working as it is good-looking. It's built from robust aluminum and wood, and is designed to carry up to 10 kg.



VanMoof Rear Carrier

This hard-working carrier has been designed to industry standards, so it fits almost all standard rear carrier bags. It's strong enough to take loads of up to 25kg.

VanMoof SLIM SET

This wall-mounting set allows you to store your Electrified S inside in even the smallest of spaces, by hanging your bike neatly against the wall. It includes a side-turning handlebar stem, foldable pedals and a strong aluminium wall mount.

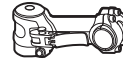

Side turning stem

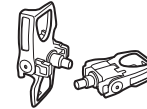

Foldable pedals

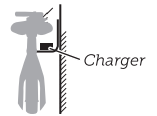

Aluminium wall mount

These accessories have been designed to fit your new Electrified S perfectly, and can be ordered at vanmoof.com

18

WARRANTY

VanMoof guarantees each new bicycle frame against defects in workmanship and materials for two years. All original components are also covered by warranty for a period of one year from the date of purchase. This warranty is expressly limited to the replacement of a defective frame, or defective parts and is the sole remedy of the warranty. This warranty applies only to original owners and is not transferable. Claims under this warranty must be made directly to the place at which you purchased the bike, and proof of purchase is required. This warranty does not cover normal wear and tear, improper assembly or follow-up maintenance, or installation of parts or accessories. The warranty does not apply to damage or failure due to accident, misuse, abuse, or neglect. Modification of the frame or components shall void this warranty. Your local VanMoof retailer shall not be responsible for incidental or consequential damages. Labour charges associated with parts change-overs are not covered by the warranty.

WARNING

This bike is made to swiftly and stylishly move through the city. Do not use it to road race, mountain bike, freeride or for any other form of non-urban cycling. Understand your bike and its intended use; choosing the wrong bicycle for your purpose can be hazardous. Using your bike the wrong way is dangerous.

WARNING

Failure to confirm compatibility, properly install, operate and maintain any component or accessory can result in serious injury or death. Do not modify your bike frame or components in any way. Modifications can cause damage leading to an accident, that can result in severe injury or death. Incompatible accessories or improper mounting of accessories can adversely affect the performance of your bicycle and may be unsafe.

WARNING

Please note all the product specific demands for third party products you add to the bike. Child and baggage carriers add weight and raise the centre of gravity making balance and cornering

DISCLAIMER

Under no circumstances, including, but not limited to negligence, shall VanMoof or VanMoof distributor (seller) be liable for any special or consequential damages that result from the use of, or the inability to use, the materials in this manual, even if VanMoof has been advised of the possibility of such damages. Applicable law may not allow the limitation or exclusion of liability or incidental or consequential damages, so the above limitation or exclusion may not apply to you.

WARNING

As with all mechanical components, bicycles are subjected to wear and tear, as well as high stresses. Different materials and components may fatigue in different ways. If the design life of a component has been exceeded, it can suddenly fail, possibly causing injuries to the rider. Any form of crack, scratches or change of colouring can indicate that the life of the components has been reached and should be replaced.

19

more difficult. If you lose control, you and your child passenger can be severely injured or killed.

WARNING

Your bicycle must comply with your countries legal requirements when riding on public roads and in all conditions, including bad weather, night time, dusk or dawn. Many countries require specific safety devices. It is your responsibility to familiarize yourself with the laws of the country where you ride and to comply with all applicable laws including properly equipping yourself and your bike as the law requires.

WARNING

Inspection and maintenance are important to the safety and longevity of your bicycle. Regularly check brakes, tyres, steering and rims. Any part of a poorly maintained bike can break or malfunction leading to an accident resulting in serious injury or death.

WARNING

Riding in the city is hazardous. Failure to wear a helmet when riding may result in serious injury or death.

20

Store these codes in a safe place:
They are proof of your bike ownership

Frame NO:



VM00000001

Bluetooth Device Name:

VANMOOF 00 00 01

IMEI NO:



0000000000000001

MAC Address:



A1:B2:C3:D4:E5:F6

ANY QUESTIONS?

Our team are here to help, 24/7. Bring your questions, big and small, to support@vanmoof.com and we'll have them answered in 24 hours. If you want to speak to a human, we're available 24/7 by phone from anywhere around the globe. If you have a VanMoof brandstore in your area you're also more than welcome to drop by and chat to us in person - we'd love to meet you!

For full details on our brand stores and contact details, see vanmoof.com